

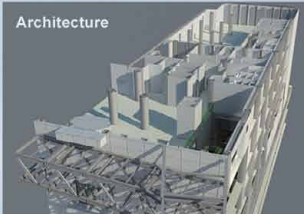

MAA Bulletin

ISSUE 49-50
SEPTEMBER 2011

BIM INTEGRATION DESIGN



Architecture

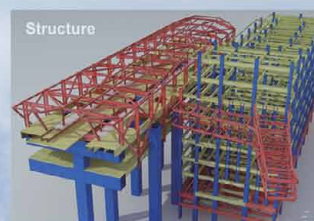

Structure

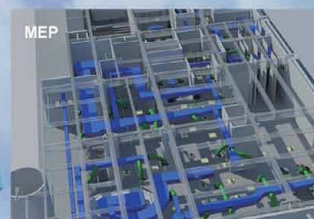

MEP



亞新工程顧問(集團)公司
MAA Group Consulting Engineers
BANGKOK BEIJING HONG KONG
SHANGHAI SINGAPORE TAIWAN

MAA Bulletin

Issue 49-50 September 2011

Founded in 1975, **MAA** is a leading Asian engineering and consulting service provider in the East and Southeast Asian region focused in the areas of infrastructure, land resources, environment, buildings, and information technology.

To meet the global needs of both public and private clients, **MAA** has a full range of engineering capabilities to provide clients with sustainable solutions - ranging from conceptual planning, general consultancy, engineering design to project management.

MAA employs 800 professional staff people with offices in the Greater China Region (Beijing, Hong Kong, Shanghai, Taiwan), Mekong Region (Bangkok), and Southeast Asia Region (Singapore), creating a close professional network in East/Southeast Asia.

MAA's goal is to establish engineering capability that will meet local needs. Along with the changes in social-economic environment over the years, **MAA's** business philosophy is to provide professional service that will become an asset to clients with long lasting benefits.

ASSET represents five key components that underlies **MAA's** principles of professional service

Advanced Technology
project Safety
client's Satisfaction
Economical Solution
Timely Completion

Produced By:
Moh and Associates Inc.
Oriental Technopolis Building A, 22 FL., No.112, Xintai Wu Road, Section 1,
Xizhi District, New Taipei City 22102, Taiwan, R.O.C.
Tel: 886-2-2696-1555
Fax: 886-2-2696-1166
Email: maagroup@maaconsultants.com
Website: www.maaconsultants.com

CONTENTS

AWARDS AND RECOGNITIONS	01
- THE 10 TH (2010) PUBLIC CONSTRUCTION GOLDEN AWARD	
- THE 12 TH (2010) NATIONAL ARCHITECTURE GOLDEN ACHIEVEMENT AWARD AND TOP NATIONAL ARCHITECTURE AWARD	
- THE 11 TH (2010) MOTC GOLDEN WAY AWARD	
- THE 2011 EXCELLENT TUNNEL ENGINEERING AWARD	
- GIANT GROUP PHARMACEUTICAL CAMPUS PROJECT – SURV AND MORPHOSIS ARCHITECTS	
- DIAMOND CERTIFICATION FOR GREEN BUILDING MATERIAL LABEL	
BUILDING INFORMATION MODELING (BIM)	07
MAA TATPEI OFFICE MOVING AND NEW OFFICE ESTABLISHED NOTICE	09
PROJECTS 1ST MAY 2010 TO 30TH APRIL 2011	10
PROFESSIONAL ACTIVITIES	20
- PROFESSIONAL ACTIVITIES	
- PROFESSIONAL AWARDS/HONORS	
- SEMINARS AND CONFERENCE	
- TECHNICAL PUBLICATIONS	
PERSONNEL PROFILES	27

ISO 9001 and LAB CERTIFICATIONS



AWARDS AND RECOGNITIONS

THE 10TH (2010) PUBLIC CONSTRUCTION GOLDEN AWARD



MAA's Chairman Dr. Za-Chieh Moh receives award during The 10th (2010) Public Construction Golden Award



The Public Construction Golden Award for project 161KV Cable Transmission Links (Anan to Fucheng) and Project and Construction Management for National Cheng Kung University Hospital

On 28th December 2010, during the Tenth (2010) Public Construction Golden Award ceremony held by the Public Construction Commission of the Executive Yuan of Taiwan, MAA Taiwan received two awards:

(1) the **Construction Design Golden Award** for the Construction of 161KV Cable Transmission Links (Anan to

Fucheng) and Underground Section from Anan to Yun River (turnkey contract).

(2) the **Construction Management Golden Award** for the Project & Construction Management for National Cheng Kung University Hospital Expansion project.

The mission of the Public Construction Golden Award is to strengthen public construction quality, improve the living and working environment, and encourage positive competitive culture in Taiwan. Each year, Golden Awards in Construction, Design and Quality are given to outstanding engineering projects completed by organizations and individuals.

161KV Cable Transmission Links (Anan to Fucheng) and Underground Section from Anan to Yun River.

The project is to construct a new main high voltage power supply system for Tainan, which includes 2.45 km underground tunnel, working shaft and underpass adjacent to power station, electrical workshop office, etc. The design works include civil, architecture and electric system. The project uses shield tunneling method instead of cut-and-cover method to reduce the impact on adjacent environment and traffic during construction period. The tunnel is one of longest boring tunnel project in Taiwan. Due to the "88 Disaster" caused by the super Typhoon Morakot in August 2009, MAA adopted a higher flood control standard in the design to protect the substation from the extreme weather conditions the world faces today.



161KV Cable Transmission Links (Anan to Fucheng) and Underground Section from Anan to Yun River

Project and Construction Management for National Cheng Kung University Hospital Expansion Project.

National Cheng Kung University Hospital is the biggest hospital in Tainan City accommodating 1093 sickbeds. The treatment of

acute, heavy and rare disease is the core medical service for the hospital. Due to the 20 years history, the hospital has encountered various problems such as lack of emergency treatment space and outdated facilities, which are critical to the medical treatment efficiency and quality improvements. As a result, the hospital planned to build a new building to solve the problems. The new 65,595 m² 10-storeys building with a 3-level basement will house outpatient department, cancer and clinical research facilities while the current building will continue to provide hospitalization, emergency treatment and critically ill departments. MAA was engaged to provide project and construction management services with special attention



National Cheng Kung University Hospital

to help produce a consistent standard operating procedure format and development process for all operating units and to provide innovative solutions for energy saving and carbon reduction methods. MAA successfully managed the standard operating procedure development process for all units and in addition adopted the design of circular caisson to avoid ground settlement.

THE 12TH (2010) NATIONAL ARCHITECTURE GOLDEN ACHIEVEMENT AWARD AND TOP NATIONAL ARCHITECTURE AWARD

The National Golden Award for Architecture was founded by the Republic of China National Enterprise Competitiveness Development Association. The National Enterprise Competitiveness Development Association was established in November 1999 with the following objectives: to improve domestic corporate image, to strengthen business operational performance of enterprise, and to help enterprises raising product quality. The goal of the Association is to increase Taiwan’s competitiveness edge in architectural construction on a national level. The 12th (2010) National Golden Award for Architecture ceremony was held on 20th October 2010.

MAA Taiwan received the National Architecture Golden Achievement Award and Top National Architecture Award for the construction of Taiwan Architecture and Technology Center of National Taiwan University of Science and Technology. The Taiwan Architecture and Technology Center is a 7-storeys building with a unique structure. The building’s structure is composed of segments that create the aesthetic appearance of sailboat sails. In addition to winning the Golden Award for Architecture, this construction project received the green



The Taiwan Architecture and Technology Center receives the National Architecture Golden Achievement Award and Top National Architecture Award

building Copper Certification from the Green Building Label of Taiwan. The project was awarded with the certification because it encompassed 6 characteristics of the Green Building Label requirements: Soil Water Content, Water Resource, Daily Energy Saving, CO₂ Emission Reduction, Sewage and Garbage Improvement and Indoor Environment. MAA Taiwan carried out project and construction management for the project.

THE 11TH (2010) MOTC GOLDEN WAY AWARD

The Golden Way Award was founded by the Ministry of Transportation and Communications (MOTC) in 2000. The mission of the MOTC Golden Way Award is to encourage organizations of roads, railways and MRT to maintain good transportation system conditions and to provide a safe and comfortable environment for users. There are 7 kinds of MOTC Golden Way Awards: landscaping, road maintenance, equipment maintenance, stations environment maintenance, information for roads users, outstanding construction, and special contribution. On 7th September 2010, MAA



Taipei MRT Wen-Hu Line Contract CB430 receives the first place of Outstanding Construction Category of the 11th (2010) MOTC Golden Way Award

Taiwan received 3 awards, winning first, third, and fourth place. MAA won awards for the following projects: Taipei MRT Wen-Hu Line Contract CB430, Project Hsin Wei Butterfly Bridge in Maolin National Scenic Area contract CK01 and Project Contract 571A of Ding-Jin System Interchange Connecting to National Highway No.10 of Broaden Construction on Yuanlin to Kaohsiung Section of Zhongshan Highway.

Taipei MRT Wen-Hu Line Contract CB430

Taipei MRT Wen-Hu Line Contract CB430 comprises a total length of 1.3 km, consisted of elevated viaduct, viaduct access ramp, cut & cover tunnel, shield tunnel with a radius as small as 140 m, and a 32 m deep underground MRT Songshan Airport

Station. An approach located at B1 floor connects the MRT station with the Songshan Airport, which used to be the only international airport for Taiwan. Today, it is an important airport that provides direct flights between mainland China and Taiwan. Due to its ideal location, the usage is now on the rise. The MRT station therefore plays a very important international gateway to Taipei metropolitan area. It is the first comprehensive transferring MRT station comprising airway, urban passenger transport and intercity transport. Due to the flight safety and operation & management of the airport, the project is a tough challenge during both design and construction phase. MAA is responsible for the design of all civil, geotechnical and structural works in addition to overall coordination and management. Due to strict management, the site never had any serious accidents, in six years of the construction.

Project Hsin Wei Butterfly Bridge in Maolin National Scenic Area contract CK01

MAA was commissioned in 2002 by the National Expressway Engineering Bureau to design and provide construction supervision of the Hsin Wei Butterfly Bridge that links National Expressway No. 27 & 28 at Da-jin Village and Hsin-wei Village in Maolin National Scenic Area, Kaohsiung County which is a long and narrow scenic area that encompasses several Purple Butterfly valleys, where every winter as many as 600,000 Euploeini butterflies take shelter in. To reflect the famous “Purple Butterfly Valleys” in the Maolin National Scenic Area, MAA specifically designed the bridge as a double-arch bridge (with a span of 145 m) to reflect the image of Euploeini purple butterfly. The total length of the two-way link is 2,320 m long, in which the bridge section is 1,735 m long. Additional passageway is designed for walking and bicycles. The project had received the Second (2008) Public Construction Safety Golden Award because of the execution of complete and high standard of health and safety measures. The receiving of the MOTC Golden Way Award further recognizes MAA’s design ability and quality of construction supervision.

Project Contract 571A of Ding-Jin System Interchange Connecting to National Highway No.10

In order to reduce the driving time from National Highway No.1 to HSR Kaohsiung Station and to relieve the heavy traffic of Ta-chung Road and surrounding of Kaohsiung Veterans General Hospital, the project is to build a turn-right ring road which connects National Highway No.1 and Highway No.10.

The ring road starts from Ding-Jin System Interchange with a total length of 780 m and 7.5 m in width that was built as an overpass. For higher quality of construction supervision, MAA sent quality control personnel to asphalt concrete plant, ready-mixed concrete plant and steel factory for ensuring quality of building material. The project was completed 4 months ahead of anticipated date.

THE 2011 EXCELLENT TUNNEL ENGINEERING AWARD

For the purpose of exchanging knowledge on tunneling techniques, tunneling related organizations and individuals co-founded the Chinese Taipei Tunneling Association in Taipei, Taiwan in June 1996. Chinese Taipei Tunneling Association is a nonprofit society with 45 corporate members and 923 individual members. The objectives of the Association are twofold: to raise the domestic level of tunneling technology through research and extension and to promote contact and cooperation with international tunnel organizations.

On 15th April 2011, the Chinese Taipei Tunneling Association conferred the Excellent Tunnel Engineering Award to MAA for services rendered on the construction of common duct on the Taipei MRT Xinyi Line.



The 2011 Excellent Tunnel Engineering Award

MAA was commissioned to undertake the preliminary and detailed design of the first common duct in Taiwan to be built with the MRT system. The common duct system will be installed parallel to the construction of the Taipei MRT, Xinyi Line. This is the first common duct in Taiwan built using a shield tunneling system. The alignment and cross-sections of the common duct changes frequently to avoid conflicting with existing utilities and to comply with structures of the Xinyi Metro line. The common duct has a total length of 5,026 m of 2~3 cell duct, which is composed of 3,134 m shield tunnel and 1,892 m open cut box culvert.

GIANT GROUP PHARMACEUTICAL CAMPUS PROJECT



Giant Group Pharmaceutical Campus and its Green Roof Design

MAA's associated architecture firm, SURV and MAA Shanghai provided design services for the Giant Group Campus, an elaborate architectural construction project located in the western suburbs of Shanghai. The Giant Group Campus is a compact village built to accommodate diverse programmatic functions in a flexible framework of architectural forms that move into and out of a sculpted landscape. The undulating office building interacts with an augmented ground plane, joining architecture to landscape and environment to site. The Giant Group Campus is an efficient, aesthetic, and sustainable building.

The East Campus office building contains three zones: open, non-hierarchical office space; private offices, and executive suites. There are other facilities integrated into the lifted landscape: a library, an auditorium, an exhibition space, and a café on the east campus. The facilities on the West Campus include a pool, a multi-purpose sports court, additional relaxation a fitness spaces for employees, and a company guest hotel with glass-floored private bedroom suites. At the south edge of the campus, a pedestrian plaza steps down to the water's edge in a continuous outdoor walkway that provides pedestrian access to the lake. There is an enclosed walkway, bridging over the street and connecting the east and west campuses.

The Giant Group Campus project is a great accomplishment in sustainability. The West Campus's landscaped green roof provides thermal mass that limits the heat gain and reduces cooling expenditures. The façade's double skin and insulated glass curtain wall minimize solar heat gain and improve overall efficiency.

The project architect is Thom Mayne, a Pritzker prize winner, of US based Morphosis Architects. MAA Shanghai was commissioned to provide design services for the Giant Group Campus project which included structural, electrical and mechanical design. SURV Shanghai served as the local architect. The total floor area of the project was 23,996 m², included the headquarters and offices for Giant Group, residence for the Chairman & all Giant Group employees, hotel, training center and clubhouse. The design period was from 2005 to 2006, and the construction period was from 2006 to 2009.



Interior Design of Giant Group Campus

Source: <http://morphopedia.com/projects/giant-interactive-group-corporate-headqu>

DIAMOND CERTIFICATION OF GREEN BUILDING LABEL

In order to meet the international trend of Sustainable Development, Architecture and Building Research Institute (ABRI) promotes “Green Building Policy” to build our living space with amenities, health, and environmental friendliness by energy saving, natural resource conservation and low pollutions. The Taiwan Architecture and Building Center (TABC) was authorized by ABRI in September 1999 to process the applications for “Green Building”. The purpose is to build ecological, energy saving, waste reduction, and healthy habitats for our living environment.

There are nine indices for assessing the approval of “Green Building”. They are: (1) Biodiversity; (2) Greenery; (3) Soil Water Content; (4) Daily Energy Saving; (5) CO₂ Emission Reduction; (6) Waste Reduction; (7) Indoor Environment; (8) Water Resource; and (9) Sewage and Garbage Improvement; A Green building may receive one of 5 different types of Label: qualified, copper, silver, golden and diamond. The diamond certification is the highest given to a green building which was evaluated to achieve all the above nine indicators.

MAA Kaohsiung received the diamond certification for the Construction of School Building (Phase 1) of National Nanke International Experimental High School in August 2010. The high school has a total area of 4.5 ha. The construction contains

buildings including Administrative & Teaching Building (general classrooms, professional training classrooms, bilingual classrooms and an underground parking lot), Dormitory, a Sports Center and Library Information Building (including a library, an audiovisual center and an international conference hall). As for the outdoor construction, the project comprises of an outdoor stadium including a tennis court, a basketball court, a valley ball court and a 300 m athletic field. MAA carried out the project construction management. This project is the first school and campus building facility that won the Diamond Certification in Taiwan.



Diamond Certification of Green Building Label for National Nanke International Experimental High School

Source: <http://www.tabc.org.tw/>

BUILDING INFORMATION MODELING (BIM)

BIM CONCEPT

In late 1990, Building Information Modeling (BIM) was first introduced to provide a virtual environment to display building structure in three-dimensions (3D). After decades' advance, BIM maturely evolved to use a product-specific sequence and generate the solid shapes and void space, with their element geometry, spatial relationships, geographic information, quantities, and properties of building components. The 3D modeling tools allow users to extract different views from a building model for drawing and demonstrating production. BIM tools can also allow elements to carry various properties and administration-purpose attributes. This allows user to select and sort attributes automatically, providing extra project benefits such as material quantity estimates and identifying and re-sequencing of project interface conflicts. These features offer a 3D, real-time, and dynamic building modeling environment, which assist various tasks during the project planning, design, construction, and operation stage.

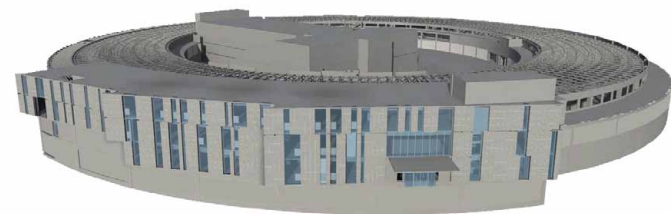
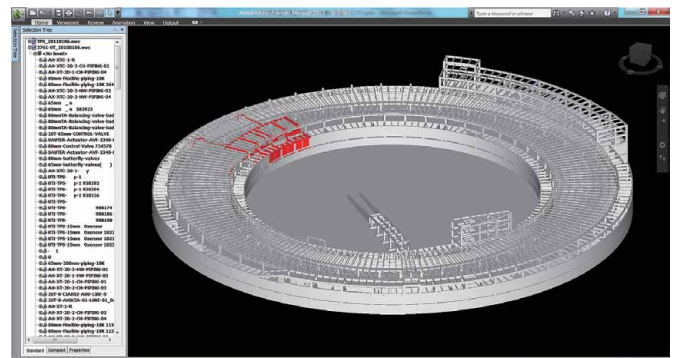
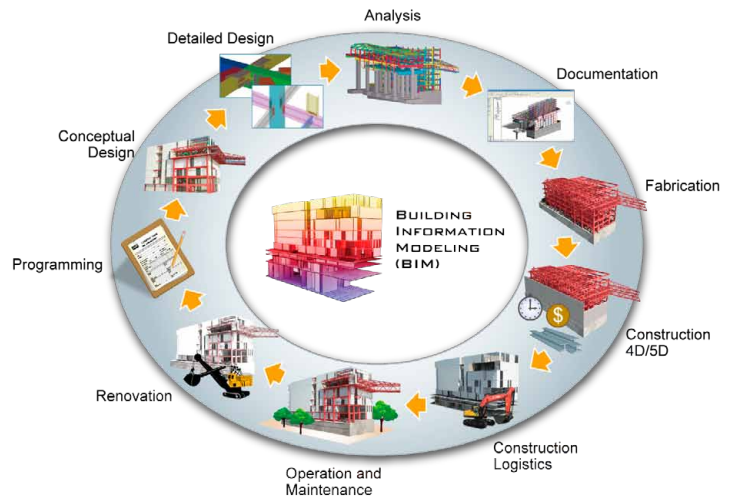

Ring-Shaped BIM Model of building and MEP line

Ring-Shaped BIM Integration Design

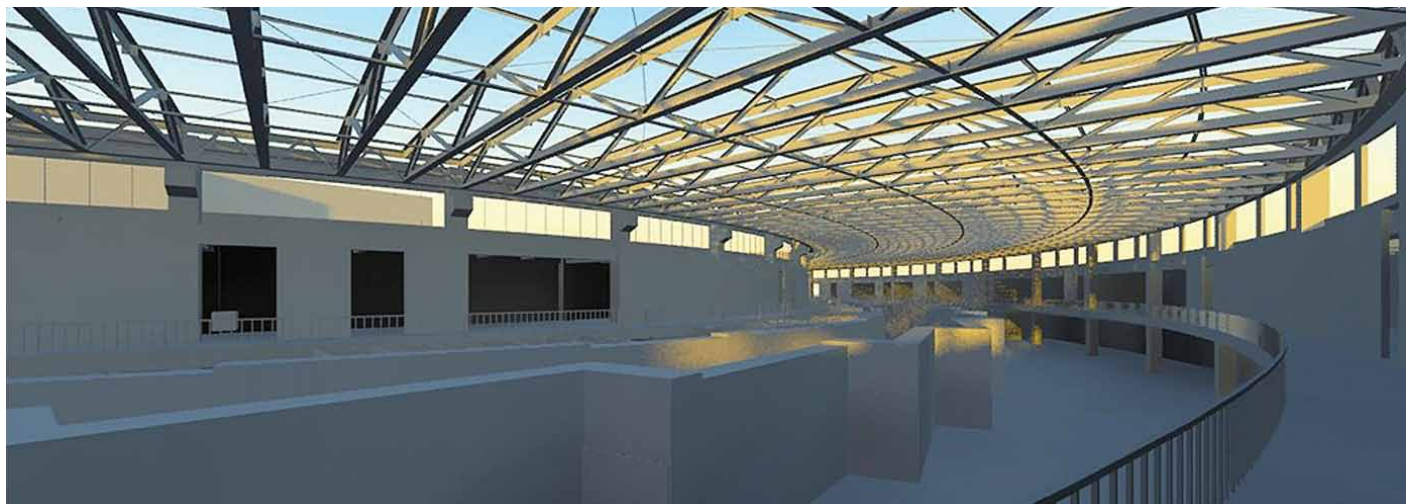

Ring-Shaped BIM Model interior

MAA SCOPE OF SERVICE

In early 2011, after 2 years' effort on internal training with actual project delivers, MAA formally established a BIM Management & Engineering Integration Center, specifically focused on BIM business development and execution. This center consists of structural, architectural, and MEP engineers targeting to provide BIM service during planning, design, and construction stages of a project. The services include:

- 1.Design in a 3D BIM environment
- 2.3D analysis capacity on specially-designed building
- 3.Visualized communication during planning, design, and construction stages.
- 4.Verification on design interface confliction
- 5.Accurate construction quantity calculation and construction sequence scheduling
- 6.Real-time 3D model display
- 7.Simulation of outdoor landscaping and estimation of individual unit space
- 8.Cost-benefit analysis of floor capacity and space usage



Taipei Metropolitan Area Rapid Transit System Circular Line Project BIM Integration Design

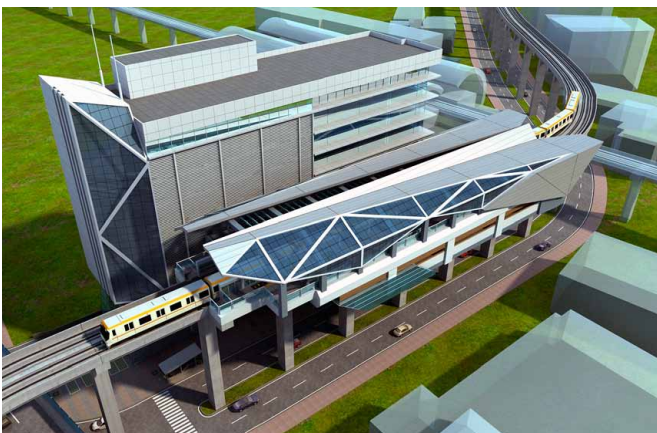

Special Design on Subway Station

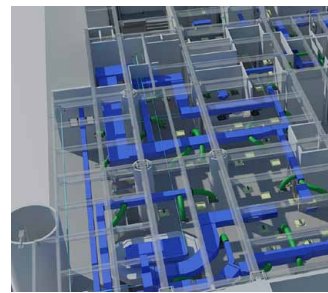

Subway Station MEP

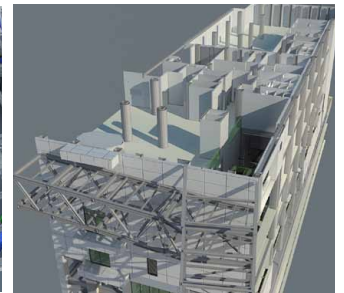

Subway Station Architecture

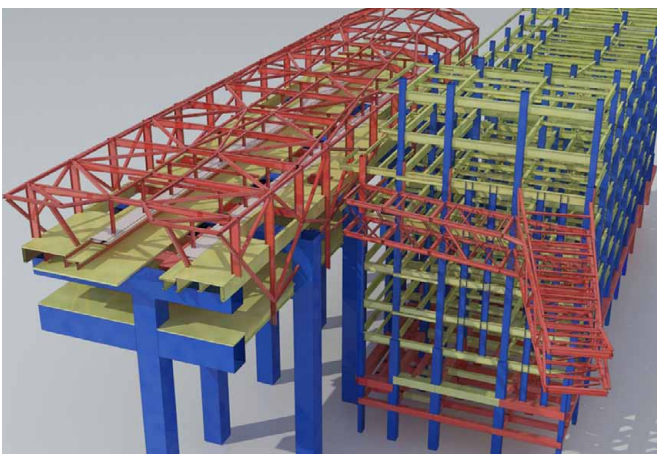

High Precision Spatial Analysis on Structure Element

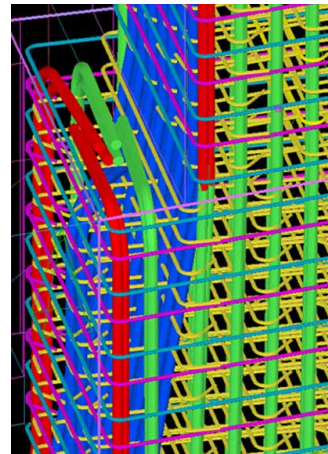

Details on RC Elements

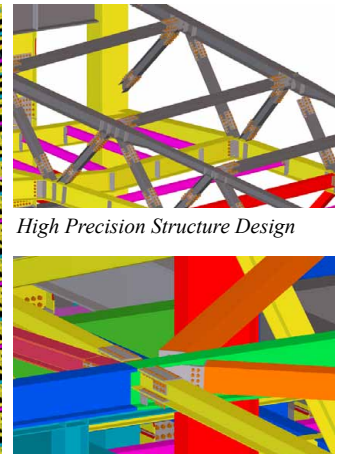

High Precision Structure Design

Steel Structure Joint

MAA TAIPEI OFFICE MOVING AND NEW OFFICE ESTABLISHED NOTICE

MAA TAIPEI MOVING NOTICE

We are pleased to announce that our office will be relocated at Oriental Technopolis Building in Xizhi, effectively from Tuesday, 11th October, 2011.

Address: Oriental Technopolis Building A, 22 Fl., No.112, Xintai Wu Road, Section 1,
Xizhi District, New Taipei City 22102, Taiwan, R.O.C.

Tel: (886-2) 2696-1555

Fax: (886-2) 2696-1166

E-mail: maagroup@maaconsultants.com

Website: www.maaconsultants.com

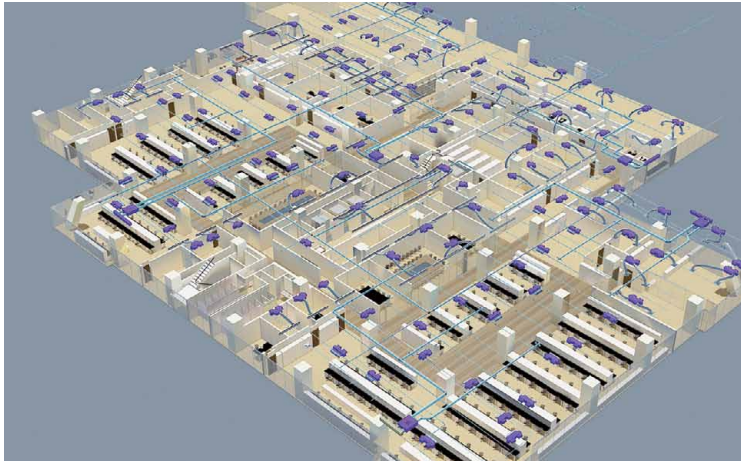

BIM Design of MAA Taipei's New Office in Xizhi Oriental Technopolis



Xizhi Oriental Technopolis

MACAU BRANCH OFFICE

The MAA Macau Branch Office was established on 23rd May 2011

Address: 澳門東望洋街15號友聯大廈1樓G座

15-G Rua De Ferreira Do Amaral, Edif. Lau Luen 1/F, Macau

TEL: (853) 2852-8787

E-mail: maagroup@maaconsultants.com

For contact, please call Mr. Yung-Her Huang

Tel: (886-2) 2696-1555 ext.1403

TAICHUNG OFFICE

The Taichung Office was established since 1st January 2011, which is supervised by Vice President Chen-Hui Hsieh. Senior Engineer An-Tai Chang is assigned as the Taichung Office Manager.

Address: Rm. A, 8F-2, No.241, Wenxin Road, Sec. 3, Xitun Dist., Taichung
40753, Taiwan, R.O.C.

TEL: (886-4) 2293-6497 FAX: (886-4) 2293-5911

E-mail: maatc@maaconsultants.com



Taichung Office

Selected Projects - 1st May 2010 to 30th April 2011

PROPOSED CONDOMINIUM HOUSING DEVELOPMENT AT LAKESIDE DRIVE, SINGAPORE

The proposed development is comprised of 3 blocks of 18-storeys residential building with swimming pool, communal facilities, and basement parking. The development is to be built close to the MRT track/viaducts (East-west Line). Almost half of the site area is located within the Railway Protection Zone (LTA, 2004). Hence, the proposed development is subjected to the restrictions and safety requirements specified by the Land Transport Authority (LTA). Because of erratic soil and rock profiles of Jurong formation in the site, there may be difficulties in the piling process. MAA provided geotechnical engineering services including soil investigation work for the foundation system and basement excavation works of the proposed development. The service period was from June to August 2010.

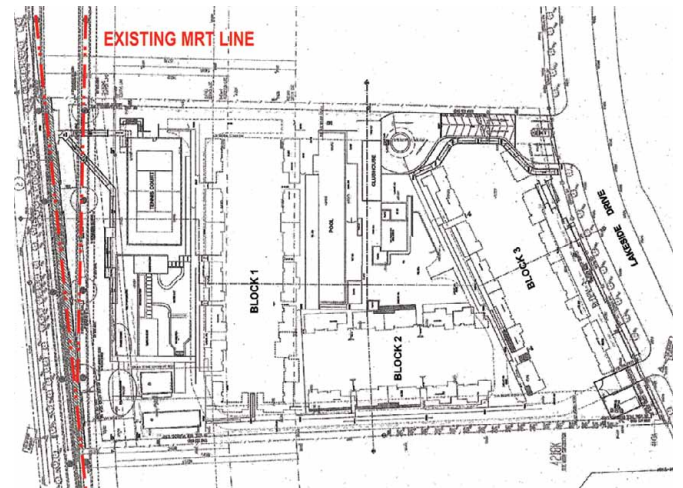

Residential Building at Lakeside Drive, Singapore

PROPOSED CONDOMINIUM HOUSING DEVELOPMENT AT LEONIE HILL ROAD, SINGAPORE

The proposed development is comprised of 2 blocks of 40-storeys residential building with swimming pool, communal facilities, and basement parking. It is to be built in the residential district, Leonie Hill Road off River Valley Road. The project site is located within the Bukit Timah Granite formation. Constructing these high-rise buildings will be challenging as the site has erratic rock formations and various degree of rock decomposition. M/s City Sunshine Holdings Pte Ltd of City Developments Group consulted MAA Singapore to provide geotechnical engineering services. MAA Singapore will investigate the soil's foundation system and excavation of the basement of the proposed development. The project service started in July and completed in September 2010.

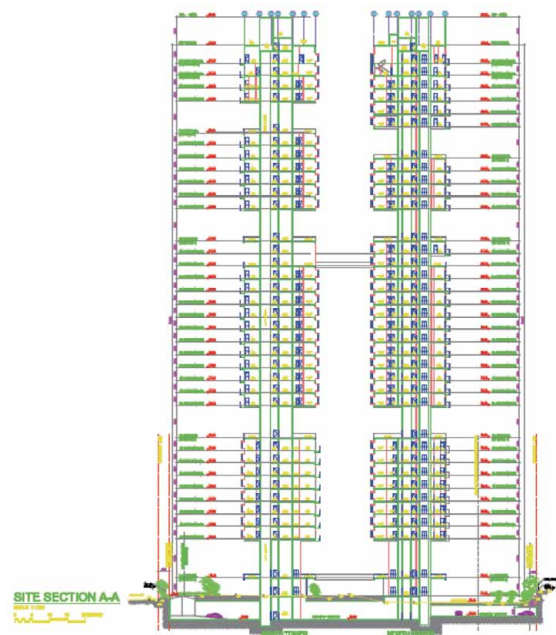

Flats at Leonie Hill Road, Singapore

DHAKA ELEVATED EXPRESSWAY PPP PROJECT

The project is composed of a dual 2 lane elevated expressway. The expressway will go from Shajalal International Airport up to Dhaka – Chittagong Highway. The total length of the expressway is 26 km. It will also have 5 interchanges, 11 tolls, and other facilities such as central control building, toll surveillance building, police station and fire rescue station. MAA Thailand was engaged by the Bangladesh Bridge Authority (BBA) to provide services including:

- Review relevant previous studies.
- Engineering data gathering such as traffic survey, topographic survey, soil investigation.
- Traffic demand for county and economic study for private sector.
- Preliminary design and cost estimate.

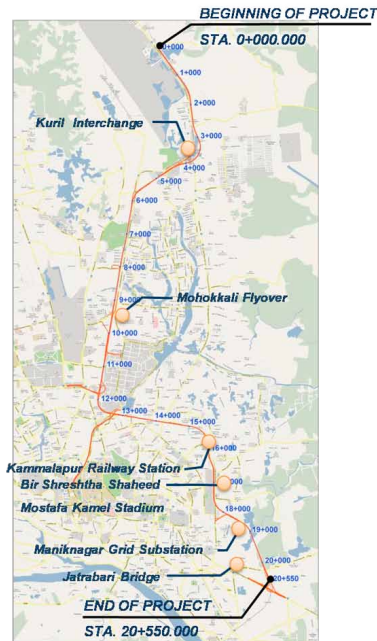

Dhaka Elevated Expressway



Design of Dhaka Elevated Expressway

DESIGN OF ROAD RECTIFICATION WORK FOR BANG BO POWER PLANT

The Bang Bo Power Plant is located in Samut Prakarn, Thailand. Operated by Alstom Asia Pacific, the main features of the power plant include a 1.3 km perimeter access road (or roadway), two internal roads, and three blocks of plant platforms with various structures. Due to soft ground condition in that area, the roadway has to be raised as part of the routine maintenance. Alstom turned to MAA Geotechnics to design a new roadway in which there would be minimal vertical stress on the subsoil. The scope of services provided by MAA Geotechnics included site investigation, monitoring the ground settlement, evaluating existing subsoil conditions and predicting future settlement, designing methods of raising roadway, preparing specifications, and drawings and billing of quantities and tender documents. The project lasted from June 2010 to October 2010.



Bang Bo Power Plant

STUDY OF EFFECT ON SUBSTRUCTURES IN BANGKOK AREA DUE TO PIEZOMETRIC PRESSURE RECOVERY IN AQUIFERS

Geotechnical exploration was conducted to study the effect of piezometric pressure recovery in the aquifers on substructures in the Bangkok area. To accomplish this study, geotechnical investigation and instrumentation works have been carried out at six different locations in Bangkok. The field work consisted of soil borings with special undisturbed samplings, standard penetration tests, and vane shear tests. The soil borings were terminated at depths of 80 m, and extensive laboratory tests such as triaxial tests, oedometer and CRS tests were conducted. Geotechnical instruments, such as VW piezometers, magnetic

extensometers and surface settlement plates were also installed at all locations to determine the piezometric pressure profiles and ground movement. Seven Associated Consultants Co., Ltd. consulted MAA Geotechnics to provide services including subsoil Investigation and geotechnical testing, geotechnical instrumentation and monitoring. The project started in July 2010 and ended in August 2011.

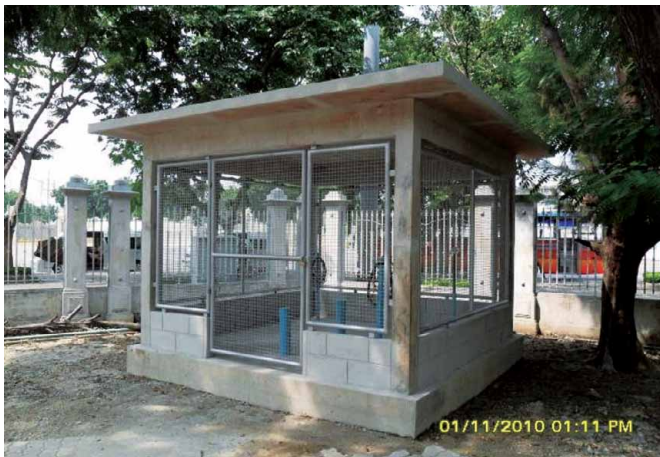

Piezometric pressure recovery in the aquifers on substructures in the Bangkok area

ENGINEERING DESIGN FOR SOFT SOIL TREATMENT AND ANCILLARY WORK FOR TAN SON NHAT-BINH LOI-OUTER RING ROAD, VIETNAM

As a part of the Ho Chi Minh City's (Vietnam) first Outer Ring Road system, a 13.7 km long roadway is planned to connect the Tan Son Nhat International Airport and Thu Duc District. The build-and-transfer project, financed by GS investment of South Korea, is scheduled to be completed by 2013. This new roadway includes three bridges crossing river and canals. To

meet the completion date of the roadway as well as to reduce foreseeable burdens on the city administration, GS E&C consulted MAA Geotechnics to redesign the soft soil treatment with consideration of latest constraints.



Tan Son Nhat – Binh Loi Outer Ring Road

CONSTRUCTION OF JETTY OF SINGAPORE LNG TERMINAL PROJECT AT MERANTI CRESCENT, JURONG ISLAND, SINGAPORE



Singapore LNG Terminal Project

The proposed work consists of the construction of a jetty to be built along the southern coastline of the SLNG Terminal Site. The project covers a shore length of about 338m at Jurong Island, Singapore. The proposed jetty consisting of six (6) mooring dolphins and four (4) breasting dolphins linking with steel walkway that will be supported on piles to be installed through reclaimed sand and inserted into the decomposed Siltstone/Sandstone of Jurong formation. Singapore LNG Pte Ltd consulted MAA Singapore to provide supervision of offshore boring works, laboratory soil/rock testing, and

geotechnical recommendations for Jetty foundation pile design. The project services started in May and will be ended in November 2011.

PROPOSED FLAT DEVELOPMENT AT SERANGOON AVE 3, SINGAPORE

The proposed condominium development is comprised of 5 Blocks of 17-storeys residential buildings with a 2-storeys podium carpark, basement parking, tennis court, swimming pool, clubhouse and communal facilities. All facilities are to be built in close proximity to the Lorong Chuan MRT Station (Circle Line) and an open canal. Half of the proposed development site area was found located within the Railway Protection Zone (LTA, 2004). Hence, the proposed development is subjected to the restrictions and safety requirements specified by the Land Transport Authority (LTA).

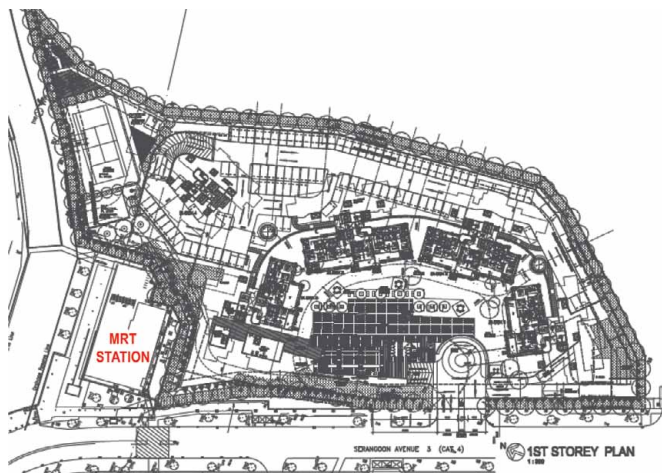

Residential Building at Serangoon Ave 3, Singapore

DESIGN AND SUPERVISION SERVICES OF THE SECOND PHASE CONSTRUCTION OF SEWAGE SYSTEM IN BANQIAO, NEW TAIPEI CITY

The project scope covers four sewage collection areas, which are in Banqiao city and part of Tucheng suburban area of New Taipei City. The total area is approximately 1,870 ha. The project includes main sewers, submain sewers, branch sewers, lateral sewers and household connection-pipes. The pipe diameters are between $\phi 300\text{mm}$ to $\phi 1,200\text{ mm}$, with a total length of 43,000 m. Household connection-pipes will

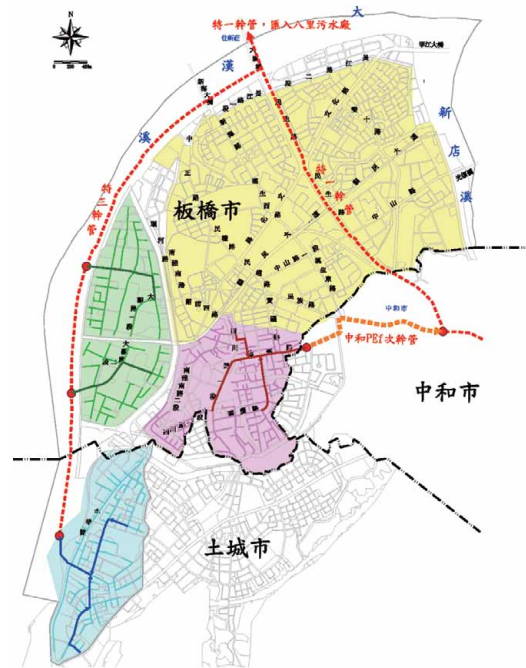

The Sewage System Plan in Banqiao

reach more than 50,000 households. Pipe-jacking method is used for submain sewers, branch sewers and lateral sewers. (pipes diameter $\leq \phi 300\text{mm}$). Open-cut method is used for the household connection-pipes (pipes diameter $\geq \phi 200\text{mm}$). MAA Taiwan was engaged by the Water Resources Bureau of New Taipei City to provide services include:

- Preparing implement plan
- Exploration drilling and geotechnical investigation
- Preliminary design
- Detailed design
- Assisting bidding and contract award
- Composing traffic maintenance plan
- Providing construction supervision

The project service started in July 2010 and is anticipated to complete in July 2016.

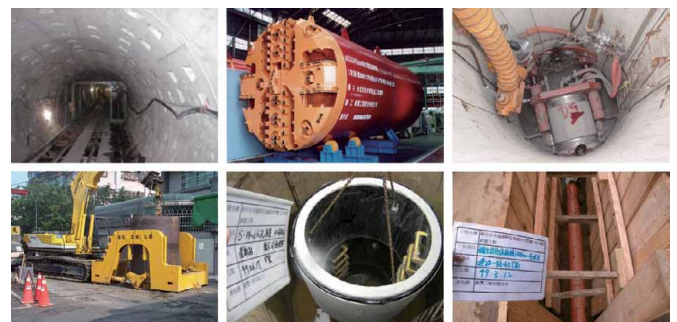

Sewers

**DESIGN OF THE GRADE-SEPARATION
PROJECT OF CHANG –PIN INDUSTRIAL AREA
INTERSECTION OF WESTERN COAST HIGHWAY**

MAA Taiwan was engaged by the Central Western Coast Highway Construction Office of Directorate General of Highways to provide services for design of grade separations for three intersections within 8.7 km length of Highway Tai 61 of the western coast highway. The location of the intersections are from sta. 166k+100 to 174k+800. The project service started in April 2010 and anticipated to be completed in December 2012.



Chang –Pin industrial area intersection of western coast highway

**TAICHUNG URBAN LAND CONSOLIDATION
(PHASE XIV)**

To enhance local development, to improve urban landscape, and to raise living standards, a high quality and low density residential environment project will be constructed at Phase XIV of the Taichung Urban Land Consolidation which is located in the northern part of the city. It will have a total area of 403.39 ha. According to the municipal consolidation plan, the modern community will be developed to accommodate 200,000 residential population. An intercontinental gymnasium for baseball and other public facilities will be built as well. The newly-built railway and mass rapid transit (MRT) will shorten the commuting time from Taichung Urban Land Consolidation (Phase XIV) to the Taichung city. Major work of the project includes topographic survey, basic design, detailed design and pipelines engineering. MAA Taiwan is commissioned by the Taichung City Government to provide design service for the project. The project service started in 2010 and is to be completed in 2016.



Taichung Urban Land Consolidation (Phase XIV)

NONG SAENG NATURAL GAS POWER PROJECT

Nong-Saeng Power Plant is a 1,600-megawatt cycle power plant that utilizes natural gas as a primary fuel, diesel oil as secondary fuel. The power plant is located at Nong Saeng, Saraburi, 120 km north of Bangkok. The project site occupies an area of 930,000 m², which are divided into 2 areas by the Raphipat Canal: the Power Plant zone and Reservoir zone. Sino-Thai Engineering and Construction Co., Ltd. consulted MAA Geotechnics to provide services for the site preparation work of the power plant. MAA Geotechnics also executed investigation and piezocone tests.



Nong Saeng Natural Gas Power Project, Thailand

XIN-ZHUANG SPORTS AND RECREATIONAL CENTER

In order to provide the public with multi-functional facilities that encourage community interaction, recreation, physical training, and competition, the New Taipei City Government plans to build the Xin-Zhuang Sports and Recreational Center, in the Xin-Zhuang Sports Park. The Sports Park will be the largest, comprehensive, and most functional park in New Taipei City. The Xin-Zhuang Sports and Recreational Center is a 3-storeys (21 m height) RC building with a 3-level basement. The total construction area is 28,313 m², and the architectural area is 7,191 m² with a total floor area of 32,506 m². MAA Taiwan was commissioned by the Sports Office, New Taipei City Government to provide Preliminary Design and Construction Supervision & Management service.



Xin-Zhuang Sports and Recreational Center

NATIONAL TAIWAN DRAMA ARTS CENTER

The purpose of the National Taiwan Drama Arts Center Project is to provide rehearsal and performing space for the Guo-Guang Opera Company, National Chinese Orchestra Taiwan, Taiwan Music Center, and Taiwan National Chorus. The construction site area is 17,631 m² and is located in Shilin District of Taipei City. The construction will include Drama House, Black-Box House, Rehearsal room, Property Workshop, Offices, Research and Promotion Spaces, Public Service Spaces, etc. The new building is a 7-storeys building with 3-storeys of basement with a total area of 35,819 m². MAA Taiwan is commissioned by the Preparatory Office of the National Headquarters of Taiwan Traditional Arts to provide Project and Construction Management service from March 2009 to June 2014.



National Taiwan Drama Arts Center

DESIGN CHANGE OF ENTRANCES AND ADAPTIVE RE-USE OF HERITAGE AT BEIMEN STATION OF SONGSHAN LINE OF TAIPEI RAPID TRANSIT SYSTEMS, DESIGN LOT DG166

Design Lot DG166 of the Songshan Line of the Taipei MRT starts from Chunghwa Road, then turns to north-east direction along the Tiensui Road, Nanjing West Road, Nanjing East Road and ends at Sungchiang Road. The total length of the route is approximately 2.9 km.

In the TRTS engineering portion, it consists of 3 stations (G14 Beimen Station, Tacheng Street, G16 Zhongshan Station and G17 Sungchiang-Nanjing Station) and three sections of twin bored tunnel using shield tunneling with 5.6 m in diameter. A common duct system with a total length of 672 m is also a part of the route. The system starts from Xinsheng North Road, aligned with the Nanjing East Road, and ends at Sungchiang Road. Remnant of the Machine Bureau of the Qing Dynasty was found at the Beimen Station after archaeological excavations of the genetic structure. Items found in the station included walls, stone road and the “four jin ya men.” These were classified as city heritage. Therefore, a research project had been conducted to find a way to reuse and renovate the excavated remains and also to integrate the entrance design with the remains for presenting a MRT station with both ancient and contemporary features. The entrance and shaft outlook will then have to pass the urban design review, followed by approved adaptive reuse of heritage. MAA Taiwan and SURV Ltd. are designers of the project.



Taipei MRT Beimen Station of Songshan Line

MACAU LRT PHASE 1 DESIGN CONTRACT C220

Phase 1 of the Macau LRT will run from the border gate in the North of Macau near the town of Zhuhai (Mainland China) to the Macau international airport in Taipa. Phase 1 of the LRT line is approximately 21 km long and has 21 stations. This line will run mainly on an elevated viaduct with only a small underground section. The Macau Section Alignment separates the project into three contracts: C210, C220, C230. Contract C220 is from No. 5 LRT station, which is close to the Fisherman Wharf entrance, to No. 9 LRT station of Nan Wan Lake (excluding No. 9 station). With a total length of about 2.36 km, including three stations: No 5, 7, and 8. The viaduct is a prestressed concrete box girder. In February 2011, the Transport Infrastructure Office of Macau SAR Government awarded a contract to the JV of G.L. Consultants of Macau and MAA Taiwan to provide services including project management, quality guarantee, civil, traffic diversion, drainage, landscaping, design and tender document preparation. The project started in February 2011 and is to be completed in December 2015.



Macau LRT Phase 1 Contract C220

CONSTRUCTION SUPERVISION CONSULTANT FOR THE BANGKOK MRT BLUE LINE EXTENSION PROJECT

The Blue Line Extension of the Bangkok MRT system is a heavy rail system extending from the existing initial Blue Line System to cover major areas in Bangkok. The extension will alleviate much of the congestion and provide for a safe, convenient and fast commuting for large volume of passengers in the greater Bangkok metropolitan area. The project consist of 2 sections, Hua Lamphong – Bang Khae, and Bang Sue –

Tha Phra, with a total length of about 27 km. About 22 km of the track is elevated and the remaining 5 km is underground. The route has 21 stations, four of them are underground and another seventeen are elevated. The project also includes depot, park and ride buildings, track system and mechanical and electrical works. MAA Thailand and MAA Taiwan were commissioned by the Mass Rapid Transit Authority of Thailand (MRTA) in December 2009 to provide Project Management and Construction Supervision Consultant services.



Bangkok Blue Line Extension Network

FEASIBILITY STUDY OF THE BLUE LINE OF TAICHUNG METROPOLITAN MASS RAPID TRANSIT SYSTEM NETWORK

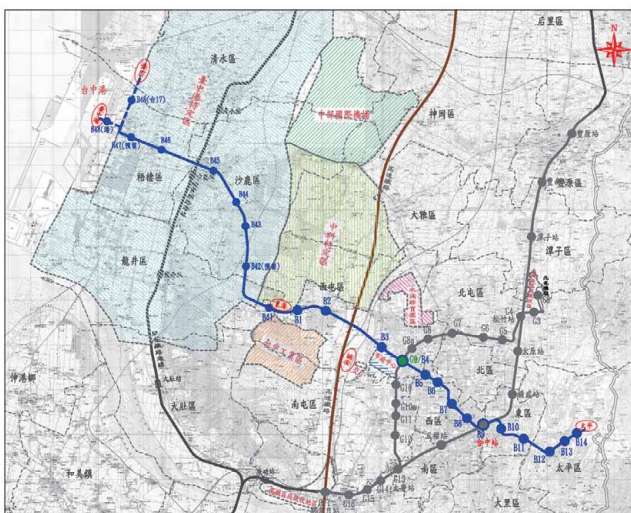

Taichung Metropolitan Mass Rapid Transit System network

The Taichung City Government began a feasibility study of the Blue Line (from Taiping to Taichung Harbor) of the metropolitan Mass Rapid Transit System in December 2010.

The Blue Line services area from Taiping District to the Taichung Harbor. The section from Tunghai University to Taiping is planned to be underground, whereas the section between Tunghai University and Taichung Harbor will be elevated. MAA Taiwan was commissioned by the Taichung MRT Agency in December 2010 to provide services including traffic survey, area development forecast, road network plan, financial plan, and execution plan. The project is expected to be completed in December 2011.

ENVIRONMENTAL IMPROVEMENT AND DESIGN OF NANJING EASTROAD AND NANJING WEST ROAD

The Nanjing East Road and Nanjing West Road will have a redesign and repavement after the completion of the MRT Songshan Line, of which a large section passes under the Roads. MAA was commissioned to provide detailed design service for the renovation project. Considerations to traffic and road services and space urban activities will be made when making designs for this project. The project runs from the intersection of Nanjing West Road and Chongqing North Road along Nanjing East and West Road to MRT Songjiang Nanjing Station on Songjiang Road, covering approximately 2.1 km. Services provided includes design of: road alignment, traffic, drainage, pipeline relocation, road & landscape lighting and sidewalk & bike lanes. The service period is from January 2011 to December 2013.

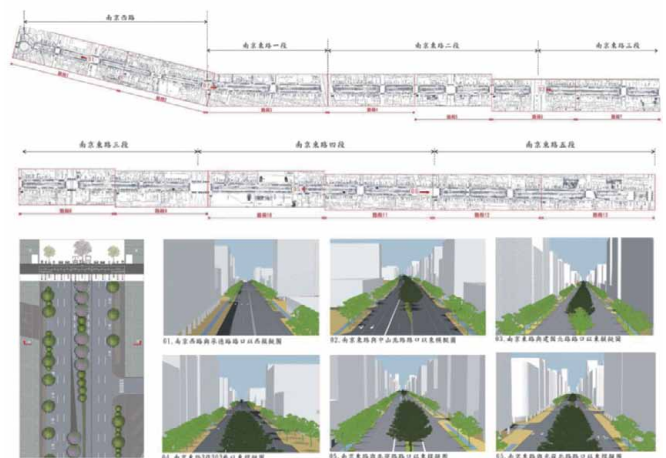

Design Renewal and Improvement of Nanjing E. and W. Rd

AN ECOLOGICALLY SUSTAINABLE NEW COUNTRY VILLAGE DEVELOPMENT PROJECT, JIAXING CITY, ZHEJIANG PROVINCE, CHINA

In January 2011, MAA was commissioned by The Jiaxing Alliance Development Corporation to provide the design services with the key mission to execute client's ambitious visions of a self-sustainable new village in Nanhu district of Jiaxing City in Zhejiang Province, China. The Jiaxing City is located in the largest flat plain area between Shanghai, Hangzhou and Suzhou. Due to its strategic location and the government's policy of maintaining a low level development, it is an ideal place to develop a village that will not only be based upon a green infrastructure concept, but also maintain the traditional rural Chiang Nan identity. The client envisions the 11.4 km² to comprise of



New Countryside Community in Jiaxing City, Zhejiang Province

a 3 km² low density mixed-use village surrounded by large areas of organic farm. The village itself includes residential districts, commercial districts, schools, hospital, public facilities and green spaces. The development will fully utilize the many waterways in the site by creating large areas of wetlands to purify the flowing water which will be used for farming and basic household usages. MAA's role is to provide a high level design service to realize the vision plans of the client and to achieve LEED (Leadership in Energy and Environmental Design, an internationally-recognized green building certification system) Gold equivalent design standards. The design services include executing a high performance sustainable water and wastewater infrastructure systems, grading system, interface with the wetland designs, power distribution, etc. In addition, MAA commits to provide the developer up-to-date advices to balance their goals with an economical design.

INVESTIGATION OF POTENTIAL DEBRIS FLOW TORRENT IN 2011

Due to the steep terrain, complex geological structure, and broken rock and abundant & concentrated rainfall in Taiwan, strong surface erosion and landslides occur frequently after every heavy rainfall. According to the "Disaster Prevention and Protection Act," the Soil and Water Conservation Bureau is required to not only conduct frequent investigation and analysis of disaster probability, risk degree, disaster simulation and risk evaluation on disaster potential creeks, but also to announce the results to the public.

MAA Taiwan was commissioned by the Soil and Water Conservation Bureau in March 2011 to investigate and evaluate 270 disaster potential creeks. MAA Taiwan will investigate 45 slope land villages for their geological safety. The villages' safety will be evaluated, and debris flow evacuation plan will be created and provided to the public for disaster prevention. The project is to be completed in December 2011.



南投縣信義鄉同富村同富聚落防災地圖-緊急疏散避難圖 (2/2)

The Investigation of Potential Debris Flow Torrent in 2011

WATER SUPPLY FOR ERLIN HIGH-TECH BASE OF PHASE 4 CENTRAL SCIENCE INDUSTRIAL PARK

This project plans to use agricultural water to provide stable water supply for the Erlin High-Tech Base of Phase 4 Central Science Industrial Park during 2012-2015. Wei Mon Industry Co., Ltd., Tsai Mon Construction Co., Ltd. and MAA Taiwan joined forces to provide turnkey services for this project. MAA will provide detail design services of Intake facility, pipeline transfer, grit chambers, equalization tanks, drying beds and electrical & instrumentation systems. The project is scheduled for completion in March 2013.



Water Supply Project for Erlin High-Tech Base of Phase 4 Central Science Industrial Park

GEOLOGICAL INVESTIGATION AND DATABASE CONSTRUCTION FOR THE UPSTREAM WATERSHED OF FLOOD-PRONE AREA (THIRD PHASE)

The goals of this project are to produce annual large scale geological maps mapping rainfall catchment areas and to record and evaluate the potential of landslides and debris flows. The results of the project will serve as a reference for management and recovery of flood-prone area. The study areas for 2011 are the catchment areas of Da-an River, Bei-gang River, Bazhang River and Zengwun River. The results will be used by the government for disaster information emergency usage and land use planning. The service period is from March to December 2011.

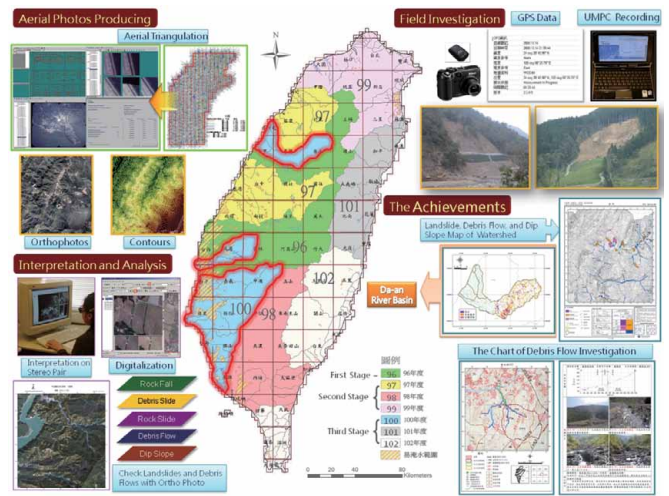

Geological Investigation and Database Construction for the Upstream Watershed of Flood-Prone Area

TURNKEY PROJECT OF 161KV POWER SYSTEM UNDERGROUND TUNNEL OF TAIWAN POWER COMPANY IN TAINAN

The turnkey project of 161kv power system underground tunnel is located in Tainan. The purpose of the project is to construct a new high voltage power supply system for Tainan, with a 2.45 km underground tunnel. The working shaft will connect the underpass work to power station, electrical workshop, and office etc. MAA was engaged by the Taiwan Power Company to provide design works including civil, architecture and electrical system. The tunnel's design is unique because it is a long distance bored tunnel project in Taiwan. The tunnel received the year's best award of Design & Construction of the Public Construction Commission, Executive Yuan in 2010.



161kv power system underground tunnel

PROFESSIONAL ACTIVITIES

- Professional Activities
- Professional Awards/Honors
- International Meetings
- Seminars and Conferences
- Technical Publications

► Professional Activities

PILING SEMINAR IN MACAU

Mr. Sio-Keong Kong, General Manager of MAA Singapore was invited by the Macau Institution of Engineers (AEM) to deliver a talk on *Technical and Environmental Issues of Pile Foundations - A Singapore Experience*, in the AEM Seminar on **Technology for Environment Friendly Piling Works in Macau** (基樁環保施工技术研討會) on 7th October 2010 in Macau.

WASTE DISPOSAL TALK IN GUANGZHOU

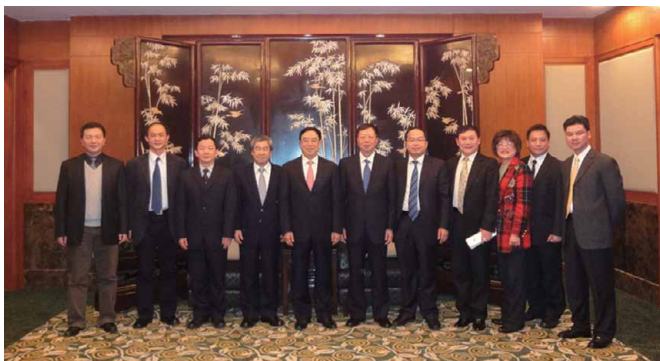

MAA representatives at the Guangzhou meeting with the Executive Vice Mayor Mr. Yi-Min Wu (Mr. Chien-I Hsu, Mr. Yung-Her Huang, Mr. Kwai-Cheung Hui)

On 21st February 2011, MAA Taiwan President Mr. Chien-I Hsu, Vice President Mr. Yung-Her Huang and Senior Engineer Mr. Kwai-Cheung Hui went to Guangzhou, China to meet the Executive Vice Mayor of Guangzhou City Mr. Yi-Min Wu (鄔毅敏) to present a waste disposal presentation. MAA presented the development of garbage treatment in Taipei City as well as MAA's experiences in waste disposal projects in Taiwan. The topics mentioned were :

- Neihu Solid Waste Dumpsite Clean Up
- Architectural Waste Classification and Disposal at Nangang Economic & Trade Park
- Waste Disposal in Linkou New Town
- Construction Waste Soil Clean Up in New Xinzhuang City Center
- Waste Disposal and Clean Up in Kaohsiung New Town

CIVIL STUDY TOUR OF HKUST

On 7th January 2011, 21 Hong Kong University of Science and Technology (HKUST) students from the Department of Civil and Environmental Engineering Students' Society came to Taipei to visit MAA's construction site of Taipei MRT Contract DR148 common duct project. Assistant Professor Dr. Jack Cheng led the students in their excursion. Two MAA staff Mr. Ting-En Wu and Mr. Chung-Ren Chou presented the design concept and guided the students to the MRT An-Ho Station and shield tunnel construction.



Civil study tour of students from Hong Kong University of Science & Technology in the common duct of Taipei MRT Contract DR148

► Professional Awards / Honors

● On 25th May 2011, Dr. Za-Chieh Moh, Chairman of MAA, received the **Honorable Aitalyev Medal** by Kazakhstan Geotechnical Society (KGS) at the 14th Asian Regional Conference on Soil Mechanics and Geotechnical Engineering, Hong Kong, China. The Presidium (Board) of the KGS and International Scientific Council of KGS resolved to found honorable international medal in memory of the remarkable Kazakhstan scientist Shmidt Musaevich Aitalyev. His scientific achievements had been recognized all over the world. This award calls to recognize the distinguished scientists of Republic of Kazakhstan in soil mechanics, rocks, geo-mechanics and underground construction area, as well as foreign specialists who had contribution to the strengthening of the close interaction between international scientific and technical societies.



● Dr. Za-Lee Moh, Retired Co-Founder of MAA, was honored with the **Distinguished Professional Civil Engineer Award** during the Taipei Professional Civil Engineer's 2011 annual meeting on 26th March 2011.



● MAA received a Letter of Appreciation for MAA's co-sponsorship of "22nd Annual Meeting" from The Chinese Institute of Environmental Engineering in November 2010.



● On 13th May 2011, Dr. Za-Lee Moh, Retired Co-Founder of MAA, was awarded a **Honorary Degree of Doctor of Engineering** by Purdue University in recognition of his innovative contribution to infrastructure design and civil engineering in the United States and Internationally. Purdue University, founded in 1869 in West Lafayette, Indiana, USA, is a major research institution known for discoveries in science, technology, engineering, and mathematics. The honorary degree is the highest award Purdue can offer which signifies both distinguished service to the University and great achievements in career and life.



Dr. Za-Lee Moh was awarded the Honorary Degree of Doctor of Engineering by Purdue University

(left 1) Dr. M. Katherine Banks, Bowen Engineering Head and Jack and Kay Hockema Professor of Civil Engineering, Purdue University

(left 2) Dr. France A. Cordova, President, Purdue University

(right 1) Dr. Leah H. Jamieson, John A. Edwardson Dean of Engineering, Purdue University

(right 2) Dr. Za-Lee Moh, Co-Founder of Moh and Associates, Inc. (Hon. Dr. degree award receiver)

● MAA received a Letter of Appreciation from Chinese Society of Structural Engineering in January 2011 in recognition for MAA's co-sponsorship of the 10th National Conference on Structural Engineering.

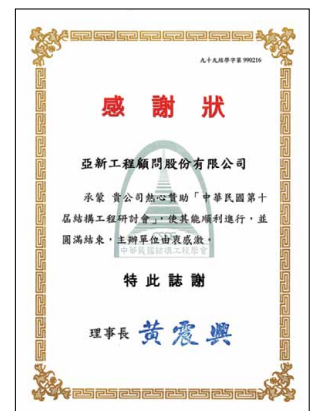

● The construction fences of Project Taipei MRT Songshan Line Contract CG590A & Xinyi Line Contract CR580B designed

by MAA received the Outstanding Award from Construction Fence Greening & Beautifying Contest held by Taipei City Government in November 2010.



- MAA received an Appreciation Award for MAA's sponsorship of the First International GSI-Asia Geosynthetics Conference from National Pingtung University of Science and Technology in November 2010.



- The Modern Multi-Functional Sports Center in Kaohsiung received Distinguished Engineering Award by Chinese Institute of Engineers in June 2010.

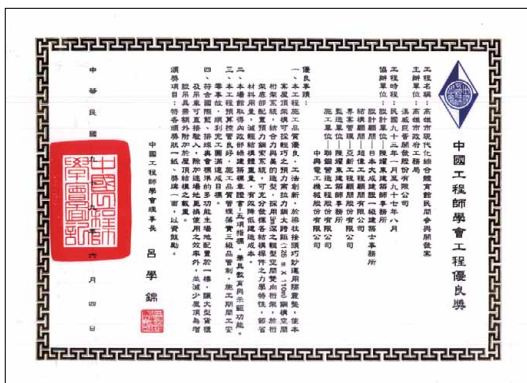

► International Meetings

INTERNATIONAL ENGINEERING ALLIANCE (IEA) MEETING

The International Engineering Alliance (IEA) is a non-governmental alliance working together to advance benchmarking and mobility in the engineering profession. There are six international agreements governing mutual recognition of engineering qualifications and professional competence. Three of Agreements cover testing qualifications in engineering. There are Washington Accord, Sydney Accord and Dublin Accord. The other three agreements cover recognitions of equivalence of the practicing engineer level. These are the APEC Engineer agreement, the Engineers mobility forum agreement and the Engineering Technologist Mobility Forum agreement.

At the 6th bi-annual meeting of the International Engineering alliance held in Taipei from 13th to 17th June 2011, Dr. Za-Chieh Moh, Chairman of the MAA Group, was unanimous elected as the Chair of the APEC Engineer Coordinating Committee for the term of 2011 to 2013. Currently, there are 14 countries/economies represented on the Committee. Dr. Moh also serves as the Chairman of the Chinese Taipei APEC/EMF Engineer Monitoring Committee.

► Seminars and Conference

WENCHUAN EARTHQUAKE REBUILD SEMINAR

On 12th May, 2008, China experienced the devastating Great Sichuan Earthquake (also known as Wenchuan Earthquake) in Sichuan Province. It measured 8.0 on the Richter scale, killing 69,227 and injuring as many as 374,176. The **Taiwan Engineering Association of Earthquake and Home Reconstruction** (臺灣工程界協助震災重建家園協會) sent professionals to the disaster area to survey the disaster and assist in reconstruction. With prior reconstruction experience in the 921 Chi Chi earthquake in Taiwan, the **Taiwan Engineering Association** was able to provide efficient and valuable assistance. After the Wenchuan Earthquake, **Sichuan**

Association of Science and Technology (四川省科學技術協會) and **Taiwan Engineering Association of Earthquake and Home Reconstruction** held a Seminar in Sichuan Province, China focused on green rebuilding and low-carbon economy and technology development. Two MAA Taiwan staff members Mr. Chin-Der LIN, Senior Manager of Environmental & Water Resources Eng. Dept. and Mr. Sz-Uei JAN, Senior Engineer, were invited to present two papers, entitled “An Introduction on Sustainable Ecological Engineering of Roadway Construction” and “Using Sustainable Engineering to Build a Green City”.

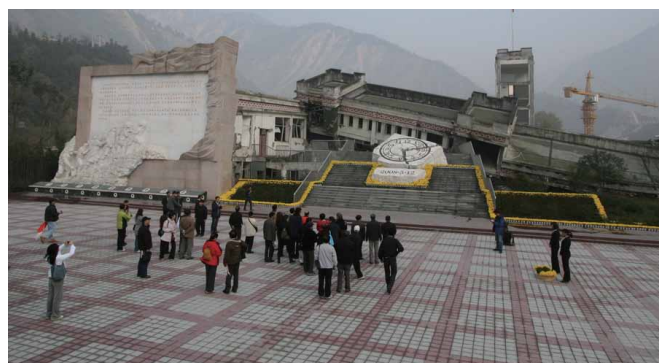

Wenchuan Earthquake Memorial Monument



The seminar of green rebuilding and Low-carbon economy development after Wenchuan Earthquake in Sichuan Province

CAPACITY BUILDING – YOUNG ENGINEER ROLE AND DEVELOPMENT IN THE ENGINEERING INDUSTRY.

This seminar was held by the Chinese Institute of Civil and Hydraulic Engineer in November 2010. The purpose of the seminar was to invite five established engineers and leaders in the industry to share their views on the changing trend in the industry and how young engineers should prepare for the future. Specifically the speakers addressed the importance of communication, management and leadership as well as the need for internationalization, diversification and crisis management to face the volatile environment. The seminar comprised of 5 topics which are as follows:

Topic 1: The Past, Present and Future of Taiwan Young Civil Engineers

Speaker: Dr. Za-Chieh Moh, Chairman of Moh and



Capacity Building – Young Engineer Role and Development in the Engineering Industry.

Associates, Inc.

Topic 2: The Effects of Internationalization and Globalization on Taiwan Young Engineers

Speaker: Dr. John Chien-Chung Li, Chairman of CECI Engineering Consultants, Inc.

Topic 3: How Can Young Engineers Create New Opportunities in the Unfavorable Environment?

Speaker: Dr. Ching-Lung Liao, Chairman of China Engineering Consultants, Inc.

Topic 4: Disciplines of a Young Engineer.

Speaker: Mr. James Tai, Chairman of T.Y. Lin Taiwan Consulting Engineers, Inc.

Topic 5: Value and Expectations of Young Engineers.

Speaker: Mr. Nelson N.S. Chou, former president of Sinotech Engineering Consultants, Ltd.

FORUM ON CAREER PLANNING FOR YOUNG ENGINEERS AT NATIONAL TAIWAN UNIVERSITY OF SCIENCE AND TECHNOLOGY (NTUST)

The Forum on Career planning for young engineers was held by the Department of Construction Engineering, NTUST and The Chinese Association of Engineering Consultants (CAEC) on 8th June 2011. Two lectures were made. MAA's Senior Vice President, Mr. Richard Moh, as representative of CAEC's Young Engineers Committee delivered a speech entitled "Career Planning and Challenges to Engineers." Two officers of the Ministry of Examination, Mr. Qing-Zhang Huang (黃慶章) and Ms. Li-Chu Zhou (周麗珠) of the Department of Senior & Junior Exam and Department of Examination Planning, respectively, gave a lecture on "Introduction of National Examination System." Other special guest panelists were invited to share their inputs to the 50 students and young engineers. Specifically they are: Mr. Ter-Chuyau Yu (余德銓), Executive Secretary of Chinese Taipei APEC Engineer Monitoring Committee; Dr. Ta-Peng Chang (張大鵬), Professor and Chairman of Department of Construction Engineering at NTUST; Dr. S. M. Lee (李順敏), Secretary General of Chinese Association of Engineering Consultants; Dr. Edward H. Wang (王華弘), Chairman of Department of Civil Engineering, Minghsin University of Science and Technology; and Mr. Paul Wang (王士鳴), Student Representative of Department of Construction Engineering at NTUST.

THE 2010 ANNUAL CONFERENCE OF CHINA NATIONAL ASSOCIATION OF ENGINEERING CONSULTANTS (CNAEC), GUANGZHOU, CHINA

The 2010 annual conference of CNAEC was held in Guangzhou from 9th - 12th December. CNAEC invited MAA's Senior Vice President Mr. Steve Wang and Mr. Richard Moh to attend the conference and delivered two lectures: "Overseas Market Development through the Cooperation of Cross-Strait Engineering Consulting Industry" and "The Challenges to Young Civil Engineers in the Coming Decades – from the Industry Perspective." The 2010 CNAEC annual conference played a significant role prior to the Twelfth Five Year National Plan of China. It is the first conference held outside of Beijing, first largest conference with an attendance of 700 representatives from all provinces of China, and lastly it was the first CNAEC conference to invite a firm from Taiwan, namely MAA.

SOFT GROUND SYMPOSIUM – TC28, ISSMGE

The 7th International Symposium on Geotechnical Aspects of Underground Construction on Soft Ground was held in Rome, Italy from 16th to 18th May, 2011. The Symposium was organized by TC28 of the ISSMGE and Italian Geotechnical Society. Dr. Za-Chieh Moh attended the 3 days symposium and made presentation of two papers.

14TH ASIAN REGIONAL CONFERENCE ON SMGE HONG KONG

The 14th Asian Regional Conference Soil Mechanics and Geotechnical Engineering was held on 23rd to 27th May, 2011 in Hong Kong. The conference was organized by the Hong Kong Geotechnical Society and the Hong Kong Polytechnic



University under the auspicious of the International Society for Soil Mechanics and Geotechnical Engineering. Dr. Za-Chieh Moh was invited by the Conference Advisory Committee to deliver a presentation on Geotechnical Activities in Asian Region as a part of the program commemorating the 75th Anniversary of the ISSMFG.



► TECHNICAL PUBLICATIONS

Chang, D.J., Ferng, S.Y., Tseng, H.C., Yu, N.T. and You, C.F. (2011), "Shield Tunneling Consideration and Mitigation Measure for Demolition Piles under Building," *Sino-Geotechnics*, Taipei, Taiwan, No, 128, June, pp.39-46

Chang, J.F., Chao, H.C. and Moh, Z.C. (2011), "Soft Ground Tunneling in Urban Areas – Proximity Effects," *paper presented at the 7th International Symposium of TC28 Geotechnical Aspects of Underground Construction in Soft Ground*, ISSMGE, 16 -18 May, Rome

Chang, J.F., Hu, I.C., Su, T.C., Chen, C.H. (2010), "3D Numerical Modeling of Pile Construction and Loading Effects on Existing Shield Tunnels," *Proc. of the Sino-Geotechnics*, Taipei, Taiwan, No.123, March, pp. 79-86. (in Chinese)

Chang, J.F. (2011) "Excavation Effects on Adjacent Construction of Rapid Transit Facilities – Case Studies," *CIE-HKIE- IEM Tripartied Seminar (Deep Excavation)*, Hong Kong, 21 May 2011.

Chang, Y. and Chang, M.K. (2011), "兩岸針對橋頭跳車問題處治對策的比較," *Engineers Times*, No.740, February, pp.2-3. (in Chinese)

Chao, H.C., Chang, J.F., Hwang, R.N. (2010), "Evaluation of Performance of Diaphragm Walls in Deep Excavations by using Deflection Path Method," *Proc., 17th Southeast Asian Geotechnical Conference*, Taipei, Taiwan, 10-13 May, vol. 1, pp. 390-393.

Chen, B.C., Chou, C.R, Chuang, C.H., Wu, T.E. and Su, T.C. (2011) "Protection Measures to A Shield Tunnel Due to Adjacent Excavation," *2011 Cross Strait Seminar on Ground Engineering*, Guangzhou, China, 12-14 May, pp. 109-116. (in Chinese)

Chou, C.R., Su, T.C. and Wu, T.A. (2011) "Case Studies of Adjacent Construction on Effects of Taipei Rapid Transit System," *The 10th Cross Strait Seminar on Tunnels and Underground Construction*, Urumqi, China, 14-15 August. (in Chinese)

Hu, I.C., Chang, J.F., Su, T.C., Chao, H.C. (2010), "3D Modeling of Pile Construction and Loading Effects on Adjacent Shield Tunnels – A Case Study," *Proc., 17th Southeast Asian Geotechnical Conference*, Taipei, Taiwan, 10-13 May, vol. 1, pp. 483-486.

Hu, I.C., Hsu, J.S. (2011), "Strain Rate Estimation for Constant Rate of Strain Consolidation Test," **The 14th Conference on Current researches in Geotechnical Engineering in Taiwan**, Taoyuan, Taiwan, 25-26 August. (in Chinese)

Huang, C.C., Lo, C.Y., Chi, C.C., Chen, H.J., Yu, C.J., Xu, J.F. and Weng, S.G. (2010), "Mapping and Zoning of Geological Hazard Susceptible Areas in Mountain Villages and Slope Land," **Proc., 2010 Annual Workshop on Research of Disaster Reduction Program for Enhancing Innovation and Implementation of Disaster Reduction**, Taipei, 5 May. (in Chinese)

Huang, T.M., Lee, Y.L., Chang, M.M., Kao, T.C., Wang, Y.P., Lee, C.C. and Huang, C.C. (2010), "The Studies and Investigation on Landslide and Debris Flow of Lanyang River Basin 2010," **Proc., Conference on Geological Investigation and Geological Hazard of Slope Land in the Watershed Area**, Taipei, November (in Chinese)

Hwang, R.N. (2011), "Underground Construction and Risk Management," **Taiwan Professional Geotechnical Engineers Association, Taipei Professional Geotechnical Engineers, Civil Engineering Technology and Education Development Foundation**, Taipei, pp. 189, (in Chinese)

Hwang, R.N., Duann, S.W., Kao, C.C. and Chen, C.H. (2011) "Risk Management for Underground Constructions," **2011 Cross Strait Seminar on Ground Engineering**, Guangzhou, China, 12-14 May, pp. 1-18. (in Chinese)

Hwang, R.N., Lee, T.Y., Chou, C.R. and Su, T.C. (2011) "Deep Excavations in the Taipei Basin," **Annual Convention of Professional Geotechnical Engineers Association**, 12 March, New Taipei City, Taiwan (in Chinese)

Hwang, R.N. and Moh, Z.C. (2011), "Performance of Deep Excavations in the Taipei Basin," **paper presented at the 7th International Symposium of TC28 Geotechnical Aspects of Underground Construction in Soft Ground**, ISSMGE, 16 -18 May, Rome

Hwang, R.N. and Moh, Z.C. (2010), "Performance of Deep Excavations in the Taipei Basin," **Proc. of the ER 2010 Earth Retention Conference 3**, Bellevue, Washington, USA, 1 August 2010.

Kang, S.M., Chen, K.T. and Li, S.R. (2011) "Making a Carbon Reducing and Energy Saving MRT- Application of Renewable Energy Technology in MRT Stations," **Rapid Transit System & Technology**, vol.43, August, pp. 119-132. (in Chinese)

Moh, Z.C. (2010), "Geotechnical Engineering for the 21st Century," **Sino-Geotechnics**, Taipei, Taiwan, No.123, March, pp.7-14, (in Chinese)

Zhuang, J.X., Su, T.C., Zhou, C.R., Yiu, C.F. (2010), "Case Study of Interaction Between Two Adjacent Excavations," **Sino-Geotechnics**, Taipei, Taiwan, No.124, June, pp. 73-78. (in Chinese)

PERSONNEL PROFILES

Wen-Shan LIU (劉文山)



Mr. Wen-Shan LIU (劉文山) was assigned as Superintendent supervising the construction supervision sites of MAA Taiwan in January 2011. He received his B.S. in Hydraulic Engineering at Feng-Chai University in 1972 and his Master in Engineering at Asian Institute of Technology, Bangkok Thailand in 1985. During 34 years of professional experience, he has been in charge of many large-scale infrastructure projects in Taiwan-area, including ground improvement with vertical drains in Keelung River old river way. His expertise is in Bridge Engineering, Architecture Construction, Railway underground Engineering, and MRT Constructions.

Mr. Ya-Lun LEE (李亞倫)



Mr. Ya-Lun LEE (李亞倫) was assigned as Superintendent supervising the construction management sites of MAA Taiwan in January 2011. He received his B.S. at Chung Yuan Christian University, Taiwan R.O.C. in 1976 and his M.S.C.E. at Nebraska State University, Neb, U.S.A in 1985. He served as a senior engineer for the San Carlos highway project in Costa Rica. Also, he has served as Deputy Project Manager for the Ta-Tang industrial park project in which he was responsible for all the engineering works during the park construction. To date, he has published two technical paper in scientific journals.

Mr. Sheng-Sheng MAO (毛聖生)



Mr. Sheng-Sheng MAO (毛聖生) was promoted to Deputy Manager of Environmental & Water Resources Eng Dept in January 2011. He graduated with a B.S. in Environmental Engineer at National Cheng Kung University, R.O.C. in 1984. Three years later, he received his M.S. in Environmental Engineering from the same school, R.O.C. In his 20 years with MAA, he has completed numerous design projects, including sewer system for Wanhua, Zhongjheng, Datong and Jhongshan districts in Taipei City. Other projects include planning, design and construction supervision of sewer system for Beitou and Shihlin districts of Taipei City and design of Domestic Wastewater Treatment Plant and Sewage System for Sun Moon Lake National Scenic Area and Northern Lin-Kou Area in Taipei County. He was also involved in project Control Management for Build, Operation and Transfer of Sewage System in Dansui District, Taipei County. In addition to design projects, he has conducted solid Waste Dumpsite Clean Up projects in Nei-Hu.

Mr. Che-Chung CHEN (陳哲中)



Mr. Che-Chung CHEN (陳哲中) was promoted to Manager of MAA Kaohsiung Office in January 2011. He has expertise in Engineering Management, Architecture, Civil Engineering, Harbor, Engineering, and Oil Facilities. He received his BEng of Civil Engineering, Chung-Cheng Institute of Technology in 1985 and then completed the Program of Engineering Management at National Defense Management College in 1988. Within his 2 years with MAA, he has served as the interface manager and deputy director for the PCM services for N-WH Project.

Mr. Chi-Hong LIN (林志宏)



Mr. Chi-Hong LIN (林志宏) was promoted to Senior Engineer II and Site Office Chief in July 2010 and is in charge of HSR Miaoli Station Special District project of Construction Supervision Department at MAA. He received his C.E. at National Taipei Institute of Technologic, R.O.C. in 1984 and his B.D.C.E. at National Taiwan Institute of Technologic R.O.C. in 1998. He served as the Supervision Engineer for the Tai-Pin Sector Expropriation Public Engineering of Taichung County project and as the Construction Supervisor for the The Promotion Project for Popular Investment of Public Construction of The Vanilla and Herb Biological Technology Park. He supervised the construction of The Da-Li Sector Expropriation Public Engineering of Taichung County and the 2006 Broadband Channels Construction Project of Cao-Tun Town.

Mr. Chien-Yi CHENG (鄭建益)



Mr. Chien-Yi CHENG (鄭建益) joined MAA in 2010 and was dispatched to Bangkok Thailand on the MRT Purple Line Project QA department as a specialist. He received his Bachelor degree in Civil Engineering at National Chen-Kung University in 1978. Mr. Cheng has major experience in civil and building construction.



Integrated Solutions For Global Impact

MAA GROUP

<http://www.maaconsultants.com>

MAA Engineering Consultants International Ltd.

Room 1810, 18th Floor, 113 Argyle Street, Mongkok Kowloon, Hong Kong SAR, China
Tel: (852) 2527-0747 Fax: (852) 2861-2081 E-mail: maahk@netvigator.com

Moh and Associates, Inc.

Oriental Technopolis Building A, 22 Fl., No.112, Xintai Wu Road, Section 1, Xizhi District,
New Taipei City 22102, Taiwan, R.O.C.
Tel: (886-2)2696-1555 Fax: (886-2)2696-1166 E-mail: maagroup@maaconsultants.com

Taichung Office

Rm. A, 8F-2, No. 241, Wenxin Road, Sec. 3, Xitun Dist., Taichung 40753, Taiwan, R.O.C.
Tel: (886-4) 2293-6497 Fax: (886-4) 2293-5911 E-mail: maatc@maaconsultants.com

Kaohsiung Office

8th Floor, No.53, Mincyuan First Road, Kaohsiung 80251, Taiwan, R.O.C.
Tel: (886-7) 536-8800 Fax: (886-7) 536-2200 E-mail: maakh@maaconsultants.com

MAA Engineering Consultants (Beijing) Co., Ltd.

Room 809-810, GuoTou Plaza, No. 7 Fu Wai Street, Xicheng District, Beijing 100037, China
Tel: (86-10) 6836-3461 Fax: (86-10) 6836-3460 E-mail: maabeijing@163.com

MAA Engineering Consultants (H. K.) Ltd.

Room 1810, 18th Floor, 113 Argyle Street, Mongkok Kowloon, Hong Kong SAR, China
Tel: (852) 2527-0747 Fax: (852) 2861-2081 E-mail: maahk@netvigator.com

MAA Engineering Consultants (Shanghai) Co., Ltd.

5th Floor, No. 89, Jiangsu North Road, Shanghai 200042, China
Tel: (86-21) 6120-3100 Fax: (86-21) 6120-3058 E-mail: maashanghai@sh.maaconsultants.com

MAA Consultants Co., Ltd.

221/1 Soi Prachachuen 37, Prachachuen Road, Bang Sue, Bangkok 10800, Thailand
Tel: (66-2) 975-9300, 975-9310 Fax: (66-2) 975-9312 E-mail: maa@maathai.com

MAA Geotechnics Co., Ltd.

39/165-7 Moo 13, Lat Phrao Road, Lat Phrao, Bangkok 10230, Thailand
Tel: (66-2) 931-0722 Fax: (66-2) 931-0724 E-mail: admin@maageo.com

Moh and Associates (S) Pte. Ltd.

#04-09 Golden Mile Complex, 5001 Beach Road, Singapore 199588
Tel: (65) 6295-0611, 6295-0608 Fax: (65) 6298-7653 E-mail: maaspl@singnet.com.sg

SURV

TAIPEI

Oriental Technopolis Building A, 22 Fl., No.112, Xintai Wu Road, Section 1, Xizhi District,
New Taipei City 22102, Taiwan, R.O.C.
Tel: (886-2) 2696-2807 Fax: (886-2) 2696-1782 E-mail: surv.tpe@urbanmatics.com

SHANGHAI

No.9, Lane 210, Taikang Road, Shanghai 200025, China
Tel: (86-21) 6415-9950 Fax: (86-21) 6472-0895 E-mail: surv.sha@urbanmatics.com